

Polltrona

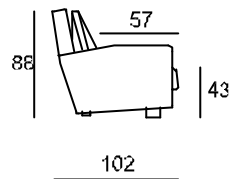

Divano 170

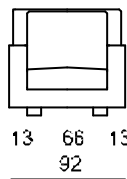
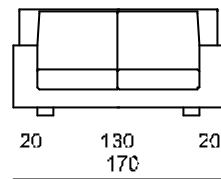

Divano 200

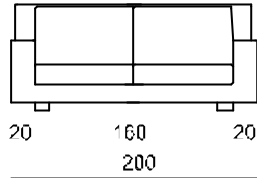

Divano 230

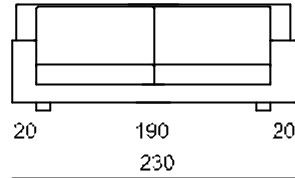

Pouf

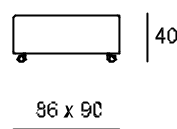

ELEMENTI COMPONENTI

Elemento "A 85" o "B 85" con 1 bracciolo S.G. o D.G.

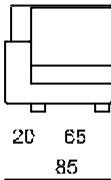

Elemento "A 100" o "B 100" con 1 bracciolo S.G. o D.G.

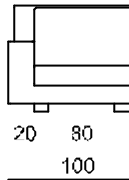

Terminale dormeuse con 1 bracciolo S.G. o D.G.

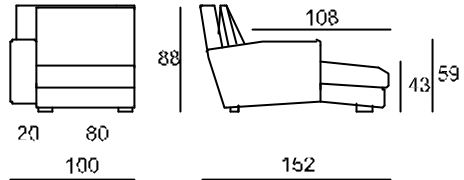

Divano 150 con 1 bracciolo S.G. o D.G.

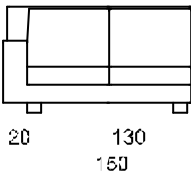

Divano 180 con 1 bracciolo S.G. o D.G.

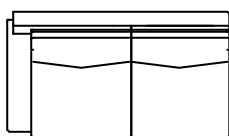
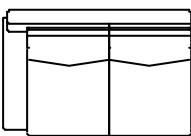
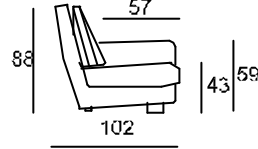
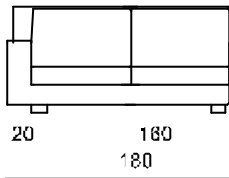

Elemento angolare 90° 178

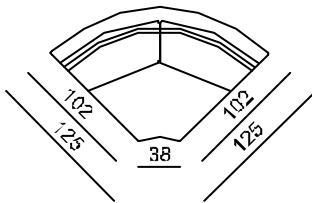

Pouf terminale rotondo S.G. o D.G. per divani/elementi con 1 bracciolo

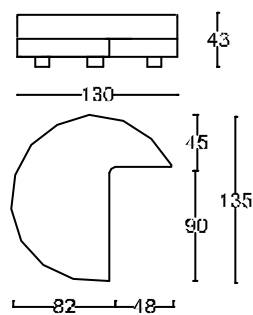

Pouf terminale rotondo S.G. o D.G. per elemento angolare 90°

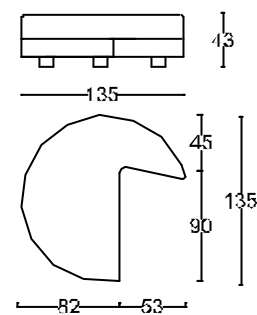

ESEMPI DI COMPOSIZIONE

Divano 150 con 1 bracciolo S.G.
 Divano 150 con 1 bracciolo D.G.

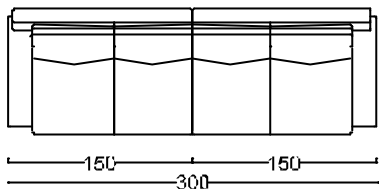

Divano 180 con 1 bracciolo S.G.
 Terminale dormeuse con 1 bracciolo D.G.

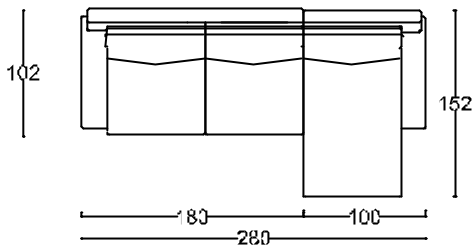

Divano 150 con 1 bracciolo S.G.
 Divano 150 con 1 bracciolo D.G.
 Elemento angolare 90°

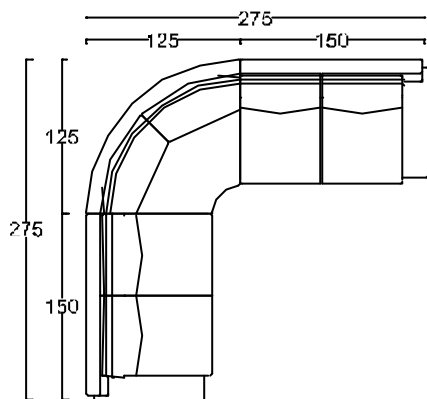

Divano 180 con 1 bracciolo S.G.
 Elemento angolare 90°
 Pouf terminale rotondo S.G.

