

S 07

Specifications
Spezifikationen
Spécifications
Technische gegevens

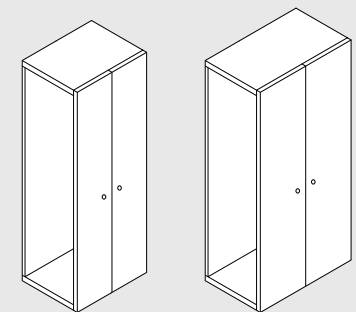

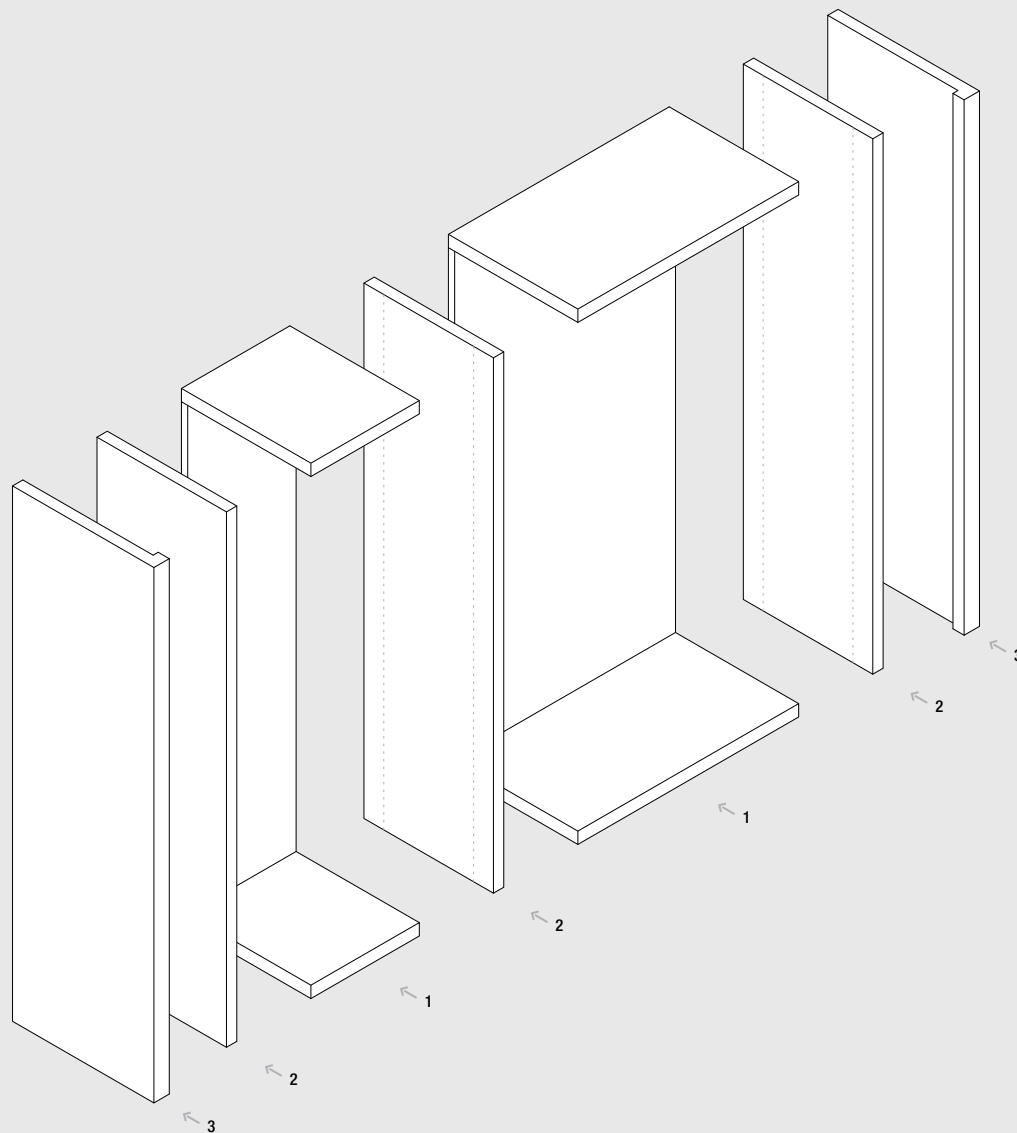

A Wardrobe structure consists of:

- individual wardrobe elements with bottom and top shelves as well as backpanels
- outside walls and middle walls
- cloaking sides (optional)

The total width is the sum of all individual components.

Un corp d'armoire est composé de:

- éléments d'armoire individuelles avec étagères inférieures et supérieures ainsi que fonds
- côtés extérieurs et montants intermédiaires
- côtés de doublage

La largeur totale est le résultat de l'addition des éléments individuels.

Ein Schrankkorpus besteht aus:

- **einzelnen Schrankelementen mit Unter- und Oberböden sowie Rückwänden**
- **Außen- und Mittelwänden**
- **Aufdoppelungsseiten (optional)**

Die Gesamtbreite erhält man durch die Addition der gewünschten Einzelteile.

Een kastromp bestaat uit:

- individueele kastelementen met onder- en bovenplanken evenals achterwanden
- buitenzijden en middenzijden
- opgedikte zijden

De totale breedte resulteert uit het optellen van de individueele samenstelling.

- 1 Wardrobe element **Schrankelement** Élément d'armoire Kastelement
- 2 Outside or middle wall **Außen- oder Mittelseite**
Côté extérieur ou montant intermédiaire Buitenzijde of middenzijde
- 3 Cloaking side (optional) **Aufdoppelungsseite (optional)**
Côté de doublage (optionnel) Opgedikte zijde (optioneel)

Depth **Tiefe** Profondeur Diepte

Heights **Höhen** Hauteurs Hoogten

Widths and variants **Breiten und Varianten** Largeurs et variantes Breedten en varianten

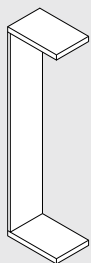

↔ 62,5

(+2,0 cm thickness of the door)
(+2,0 cm Türstärke)
 (+2,0 cm épaisseur de la porte)
 (+2,0 cm dikte van de deur)

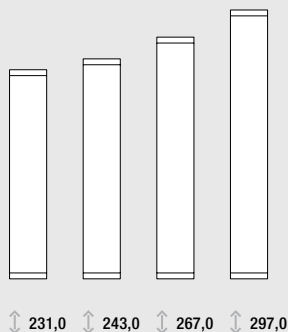

↕ 231,0 ↕ 243,0 ↕ 267,0 ↕ 297,0

Hinged doors
Drehtüren
 Portes battantes
 Draaideuren

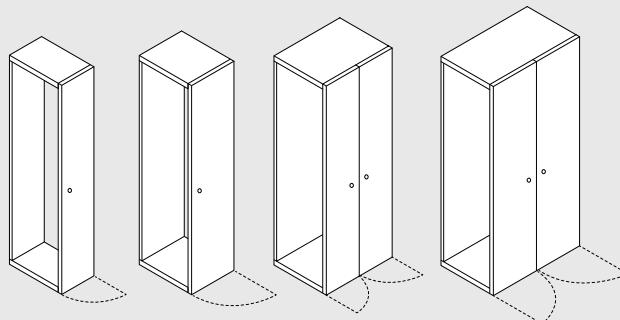

↔ 41,0 ↔ 54,0 ↔ 84,0 ↔ 110,0

Angled element
Schrägelement
 Élément en biais
 Afgeschuinde kast

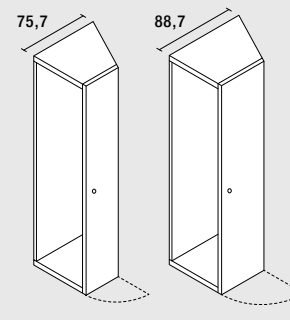

↔ 41,0 ↔ 54,0

Corner element with pillar
Eckelement mit Stillstand
 Élément d'angle avec arrêt
 Hoekelement met stijl

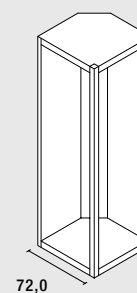

↔ 72,0

Swivel door
Schwenktür
 Porte à débattement
 Zwenkdeur

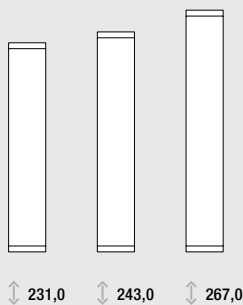

↕ 231,0 ↕ 243,0 ↕ 267,0

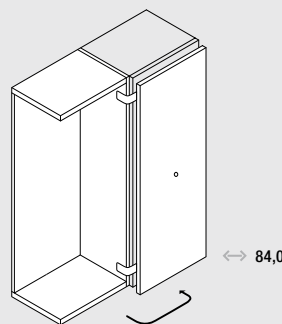

↔ 84,0

Pull-out unit
Ziehschrankenelement
 Élément d'armoire extractible
 Uittrekkast-element

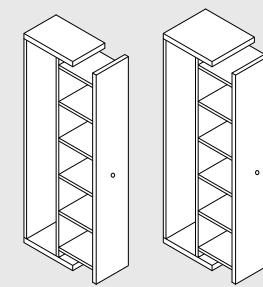

↔ 41,0 ↔ 54,0

Corner element without pillar
Eckelement ohne Stillstand
 Élément d'angle sans arrêt
 Hoekelement zonder stijl

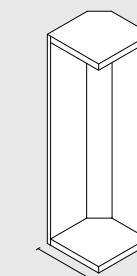

↔ 65,5

Depth **Tiefe** Profondeur Diepte

Heights **Höhen** Hauteurs Hoogten

Widths and variants **Breiten und Varianten** Largeurs et variantes Breedten en varianten

Continuous or tripartite doors **Durchgehende oder dreigeteilte Türen** Portes d'un seul tenant ou en trois parties Doorgaande of in drieën gedeelde deuren

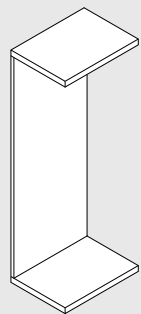

↔ 59,1

(+ 10,9 cm thickness of the gliding doors incl. handle strip)

(+ 10,9 cm **Schwebetürenstärke inkl. Griffleisten**)

(+ 10,9 cm épaisseur de la porte coulissante y inclus poignées-profilés)

(+ 10,9 cm dikte van de zweefdeur incl. greeplijst)



↕ 231,0



↕ 243,0

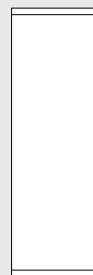

↕ 267,0

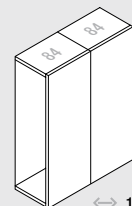

↔ 170,0

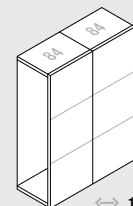

↔ 170,0

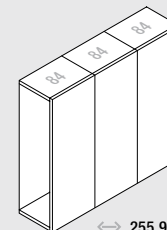

↔ 255,9

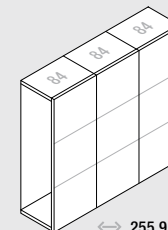

↔ 255,9

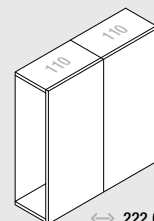

↔ 222,0

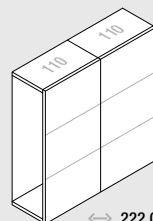

↔ 222,0

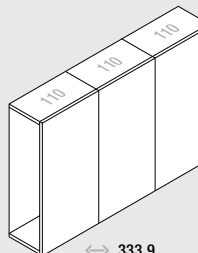

↔ 333,9

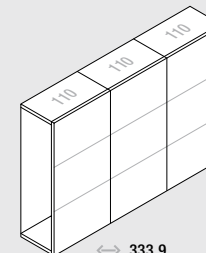

↔ 333,9

Tripartite doors **Dreigeteilte Türen** Portes en trois parties In drieën gedeelde deuren

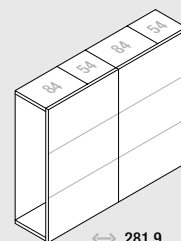

↔ 281,9

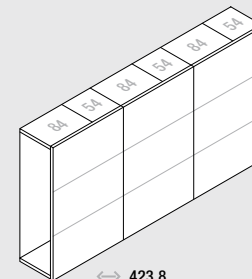

↔ 423,8

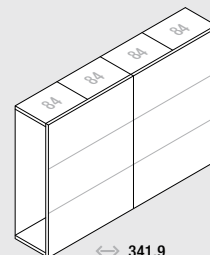



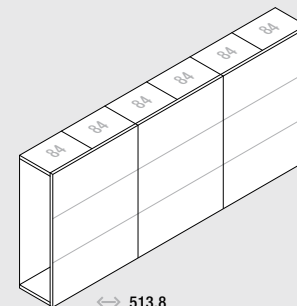



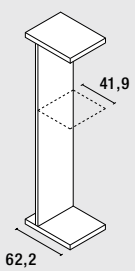

↔ 341,9

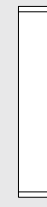
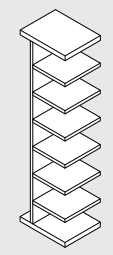
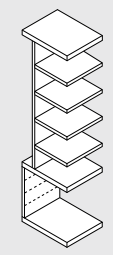
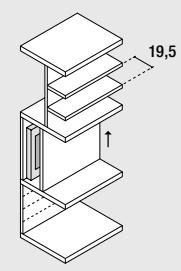

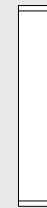
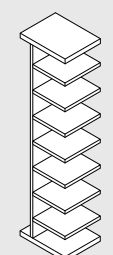
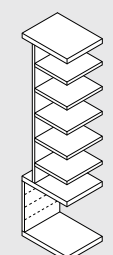
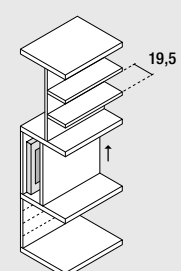
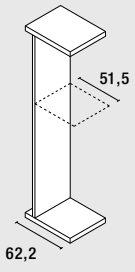
↔ 513,8

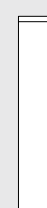
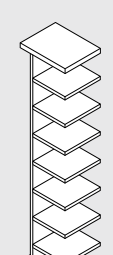
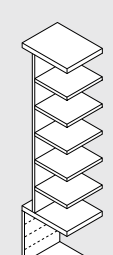
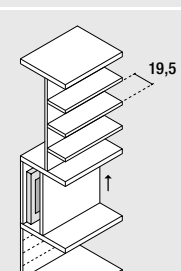
Open elements **Offene Elemente** Eléments ouverts Open elementen

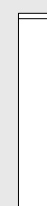
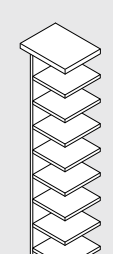
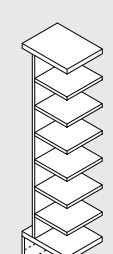
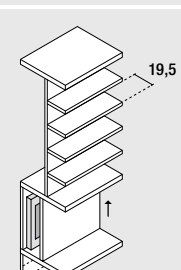
Depths Tiefen Profondeurs Diepten	Widths Breiten Largeurs Breedten	Heights Höhen Hauteurs Hoogten	Shelf elements Regalelemente Eléments de rayonnage Open kastelementen	With compartment Mit unterem Fach Avec compartiment Met vak	With TV compartment (without/with door)* Mit TV-Fach (ohne/mit Tür)* Avec niche TV (sans/avec porte)* Met TV vak (zonder/met deur)*	
 62,2 41,9	 ↔ 35,9	 ↕ 231,0			 19,5	
	 ↔ 48,9	 ↕ 243,0			 19,5	
	 62,2 51,5	 ↔ 78,9	 ↕ 267,0			 19,5
	 ↔ 104,9	 ↕ 297,0			 19,5	

*TV compartments only in widths 78,9 and 104,9 *TV-Fächer nur in den Breiten 78,9 und 104,9 *Niches TV uniquement dans les largeurs 78,9 et 104,9 *TV vakken alleen in de breedtes 78,9 en 104,9

Depth **Tiefe** Profondeur Diepte

Heights **Höhen** Hauteurs Hoogten

Inserts (variable) **Einsätze (variabel)** Inserts (variables) Inzetten (variabel)

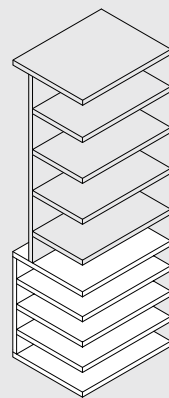
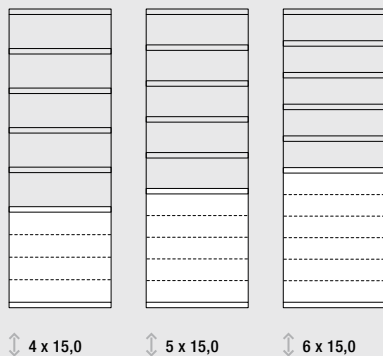
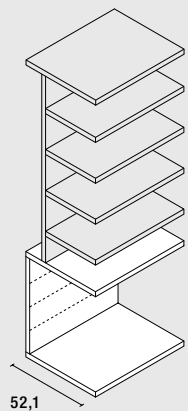

Shelves
Böden
Étagères
Legplanken

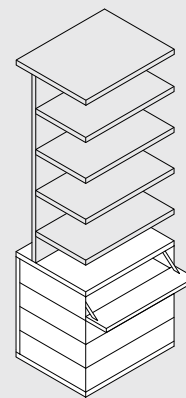

Flaps
Klappen
Abattants
Kleppen

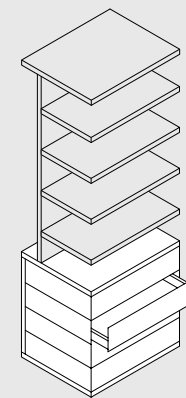

Drawers
Schubkästen
Tiroirs
Laden

Outside and middle walls **Außenseiten und Mittelwände** Côtés extérieurs et montants intermédiaires Buitenzijden en middenzijden

Cloaking side **Aufdoppelungsseite** Côté de doublage Opgedikte zijde

Thickness **Stärke** Epaisseur Dikte

Heights **Höhen** Hauteurs Hoogten

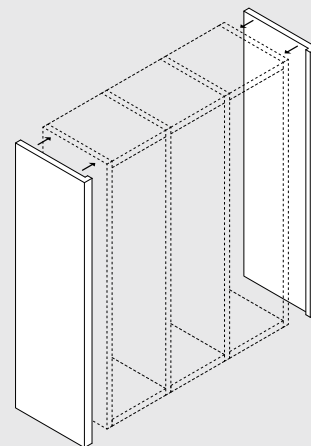
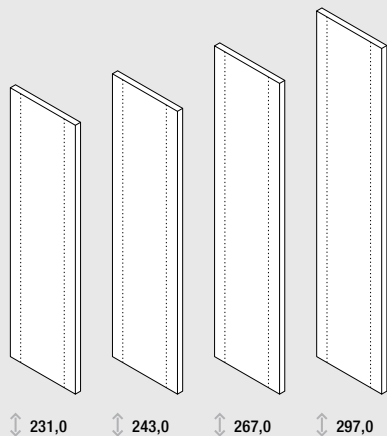
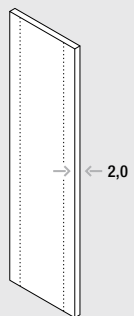

Left and right each
+ 2,0 cm wall thickness

**Links und rechts je
+ 2,0 cm Seitenstärke**

A gauche et à droite
+ 2,0 cm épaisseur du côté

Links en rechts
+ 2,0 cm sterkte van zijde

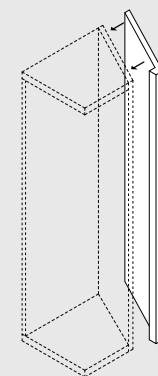

Left and/or right
+ 4,2 cm wall thickness

**Links und/oder rechts
+ 4,2 cm Seitenstärke**

A gauche et/ou à droite
+ 4,2 cm épaisseur de côté

Links en/of rechts
+ 4,2 cm sterkte van zijde