

**Korpussystem** | body-system | Korpussystem

**Holzarten** | types of wood | houtsoorten

ER, BU, BK, EI-N, KB, NB, EI-W

**Türen/Klappen: Holz | Rahmen | Glas**

doors/leaves: wood | frame | glass, deuren/klepen: hout | kozijn | glas

**Schiebetüren: Holz | Glas**, sliding doors: wood | hout,

schuifdeuren: hout | glas

**Fachböden: Holz | Glas (hinter Glastüren)**

shelf: wood | glass (behind glass doors),

legbank: hout | glas (achter glazen deuren)

**Laden: Metall-Vollauszug mit gedämpftem Selbsteinzug**

Drawers: all drawers come with full-pull out mechanism in metal

and quiet self closing mechanism

Laden: metalen geleiding met geluidsarme zelfsluitingsmechaniek

vanaf een diepte

**Griffe: Klappgriff Holz, Klappgriff Edelstahl, Edelstahlknopf,**

**Touchbeschlag\*** | handle: flap handle-wood, flap handle-stainless steel,

stainless steel-knob, touch fitting\*

greep: uitklapbare handgreep-hout, uitklapbare handgreep-roestvrij

staal, roestvrijstalen knop, aanraakbeslag\*

**Touchbeschlag (bei Klappen und Laden, Höhe 15,6 und 23,5)**

touch fitting (for hatches and drawer height of 15,6 and 23,5)

tiptoets (bij kleppen en laden hoogte van 15,6 en 23,5)

**Farben siehe unten** | colors see below | kleuren zie hieronder

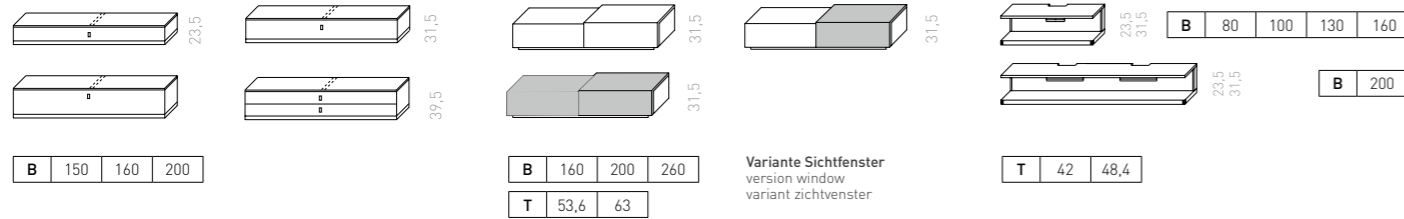
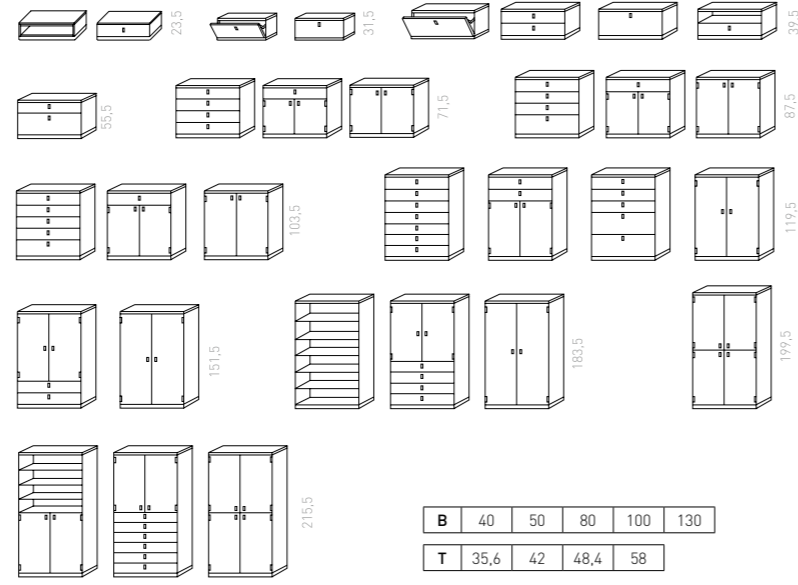

**Planungsbeispiel** | planning-example | voorbeeld van een ontwerp

Einzelne Korpuse lassen sich mittels durchgehender, massiver Deckplatte sowie durchgehendem, massivem Sockel fugenlos kombinieren. |

Individual bodies can be joined seamlessly by one continuous solid top and also by one continuous solid base.

Losse kastelementen kunnen van een massief bovenblad uit één geheel en ook een massieve plint uit één stuk worden voorzien.

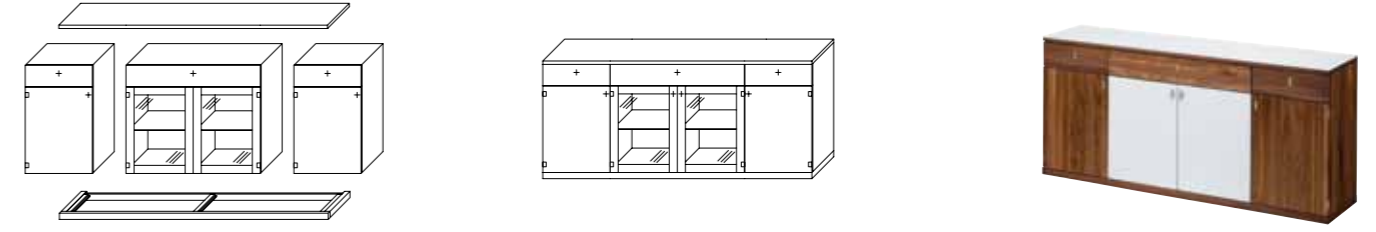

**cubus quadrat Korpussystem** | body-system | Korpussystem

**Holzarten** | types of wood | houtsoorten

ER, BU, BK, EI-N, KB, NB, AH-W, EI-W

**Deckplatte: Holz voll, Farbglas** | cover panel: solid wood, glass

bovenblad: geheel hout, glas

**Front: Holz (Maserung waagrecht), Farbglas siehe unten**

front: wood (horizontal grain), colored glass see below

voorzijde: hout (liggend vlammenmotief) getint glas zie hieronder

**Griffe: Klappgriff Holz, Klappgriff Edelstahl, Touchbeschlag\***

handle: flap handle-wood, flap handle-stainless steel, touch fitting\*

greep: uitklapbare handgreep-hout,

uitklapbare handgreep-roestvrij staal, aanraakbeslag\*

**Fußgestell/Hängevorrichtung: Sockel H: 4,6, Kufe H: 12,6 cm,**

**Holzfußgestell H: 15 cm, Hängevorrichtung bis Tiefe 39,5 cm**

Center leg/wall mount: with base, slide, base with legs,

hanging system up to 42 depth | Pootframe/ophangvoorziening:

met plint, glijder, houten pootframe, opjamsytee, tot 42

**Tiefe 35,6 cm, 42 cm, 48,4 cm** | depth 35,6 cm, 42 cm, 48,4 cm

diepte 35,6 cm 42 cm, 48,4 cm

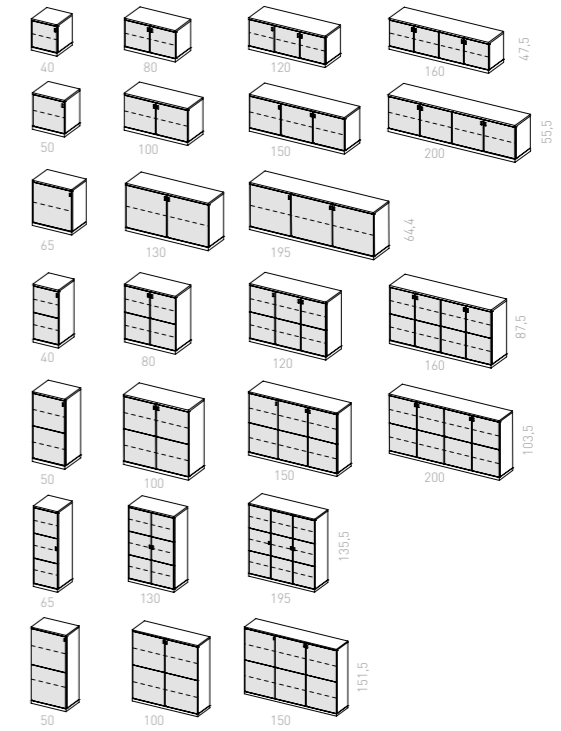

**Holzarten** | types of wood | houtsoorten

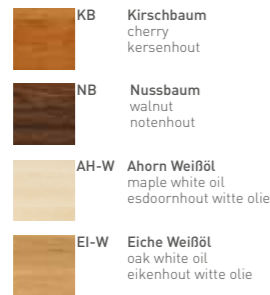
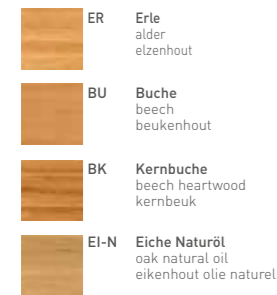

**Farbglas glänzend oder matt**  
colored glass gloss or matte | gekleurd glas glanzend of mat



**Fronten Übersicht**  
summary of fronts  
Fronten - overzicht

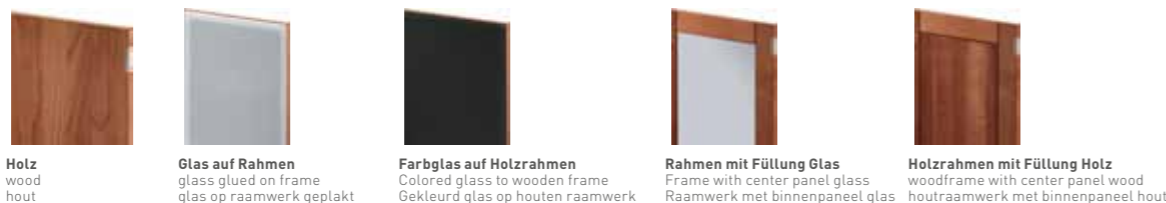

**Fußgestell/Hängevorrichtung** | center leg/wall mount | pootframe/ophangvoorziening



\* Klappgriff Holz und Edelstahlknopf nur für Holzfront  
flap handle and knob stainless steel only for wood front  
kleggreep en rvs-knop alleen voor houten front  
**H** Höhe | height | hoogte  
**B** Breite | width | breedte  
**T** Tiefe | depth | diepte

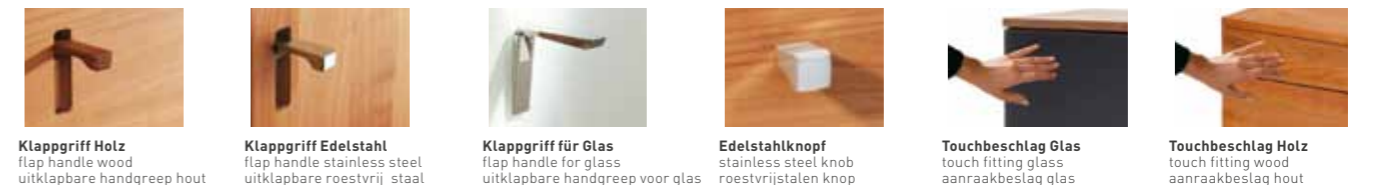



**Korpussystem mit Aufsatzregal** | body-system | Korpussystem

**Holzarten** | types of wood | houtsoorten  
ER, BU, BK, EI-N, KB, NB, AH-W, EI-W  
**Türen/Klappen:** Holz | Rahmen | Glas  
doors/leaves: wood | frame | glass, deuren/klepen: hout | kozijn | glas  
**Schiebetüren:** Holz | Glas, sliding doors: wood | hout, schuifdeuren: hout | glas  
**Fachböden:** Holz | Glas (hinter Glastüren)  
shelf: wood | glass (behind glas doors), legbank: hout | glas (achter glazen deuren)  
**Laden:** Metall-Vollauszug mit gedämpftem Selbststeinzug  
\*ab Tiefe 38 (Regal) / 42 (Korpus)  
Drawers: all drawers come with full-pull out mechanism in metal and quiet self closing mechanism \* from 38 (shelve) / 42 (body) depth  
Laden: metalen geleiding met geluidsarme zelfsluitingsmechaniek vanaf een diepte \*van 38 (plank) / 42 (ladentafel)  
**Griffe:** Klappgriff Holz, Klappgriff Edelstahl, Edelstahlknopf, Touchbeschlag\* | handle: flap handle-wood, flap handle-stainless steel, stainless steel-knob, touch fitting\*  
greep: uitklapbare handgreep-hout, uitklapbare handgreep-roestvrij staal, roestvrijstalen knop, aanraakbeslag\*  
**Touchbeschlag (bei Klappen und Laden, Höhe 15,6 und 23,5)**  
touch fitting (for hatches and drawer height of 15,6 and 23,5)  
tptoets (bij kleppen en laden hoogte van 15,6 en 23,5)  
**Farben siehe unten** | colors see below | kleuren zie hieronder

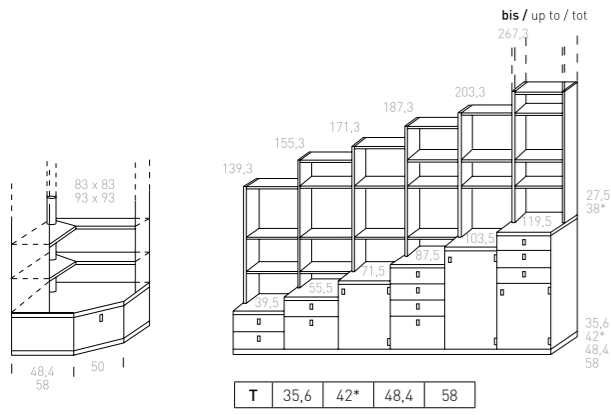

**cubus Regalsystem** | body-system | Korpussystem

**Holzarten** | types of wood | houtsoorten  
ER, BU, BK, EI-N, KB, NB, AH-W, EI-W  
**Türen/Klappen:** Holz | Rahmen | Glas  
doors/leaves: wood | frame | glass, deuren/klepen: hout | kozijn | glas  
**Schiebetüren:** Holz | Glas, sliding doors: wood | hout, schuifdeuren: hout | glas  
**Fachböden:** Holz | Glas (hinter Glastüren)  
shelf: wood | glass (behind glas doors), legbank: hout | glas (achter glazen deuren)  
**Laden:** Metall-Vollauszug mit gedämpftem Selbststeinzug  
\*ab Tiefe 38 (Regal) / 42 (Korpus)  
Drawers: all drawers come with full-pull out mechanism in metal and quiet self closing mechanism \* from 38 (shelve) / 42 (body) depth  
Laden: metalen geleiding met geluidsarme zelfsluitingsmechaniek vanaf een diepte \*van 38 (plank) / 42 (ladentafel)  
**Griffe:** Klappgriff Holz, Klappgriff Edelstahl, Edelstahlknopf, Touchbeschlag\* | handle: flap handle-wood, flap handle-stainless steel, stainless steel-knob, touch fitting\*  
greep: uitklapbare handgreep-hout, uitklapbare handgreep-roestvrij staal, roestvrijstalen knop, aanraakbeslag\*  
**Touchbeschlag (bei Klappen und Laden, Höhe 15,6 und 23,5)**  
touch fitting (for hatches and drawer height of 15,6 and 23,5)  
tptoets (bij kleppen en laden hoogte van 15,6 en 23,5)  
**Farben siehe unten** | colors see below | kleuren zie hieronder

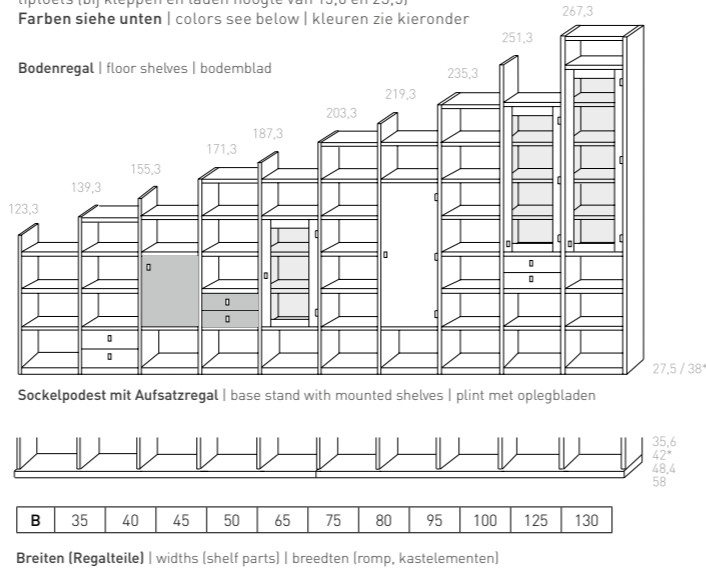

**cubus Bibliothek** | book case | boekenkast

**Holzarten** | types of wood | houtsoorten  
ER, BU, BK, EI-N, KB, NB, EI-W  
**Türen/Klappen:** Holz | Rahmen | Glas  
doors/leaves: wood | frame | glass, deuren/klepen: hout | kozijn | glas  
**Schiebetüren:** Holz | Glas, sliding doors: wood | hout, schuifdeuren: hout | glas  
**Fachböden:** Holz | Glas (hinter Glastüren)  
shelf: wood | glass (behind glas doors), legbank: hout | glas (achter glazen deuren)  
**Laden:** Metall-Vollauszug mit gedämpftem Selbststeinzug  
\*ab Tiefe 38 (Regal) / 42 (Korpus)  
Drawers: all drawers come with full-pull out mechanism in metal and quiet self closing mechanism \* from 38 (shelve) / 42 (body) depth  
Laden: metalen geleiding met geluidsarme zelfsluitingsmechaniek vanaf een diepte \*van 38 (plank) / 42 (ladentafel)  
**Griffe:** Klappgriff Holz, Klappgriff Edelstahl, Edelstahlknopf, Touchbeschlag\* | handle: flap handle-wood, flap handle-stainless steel, stainless steel-knob, touch fitting\*  
greep: uitklapbare handgreep-hout, uitklapbare handgreep-roestvrij staal, roestvrijstalen knop, aanraakbeslag\*  
**Touchbeschlag (bei Klappen und Laden, Höhe 15,6 und 23,5)**  
touch fitting (for hatches and drawer height of 15,6 and 23,5)  
tptoets (bij kleppen en laden hoogte van 15,6 en 23,5)  
**Farben siehe unten** | colors see below | kleuren zie hieronder

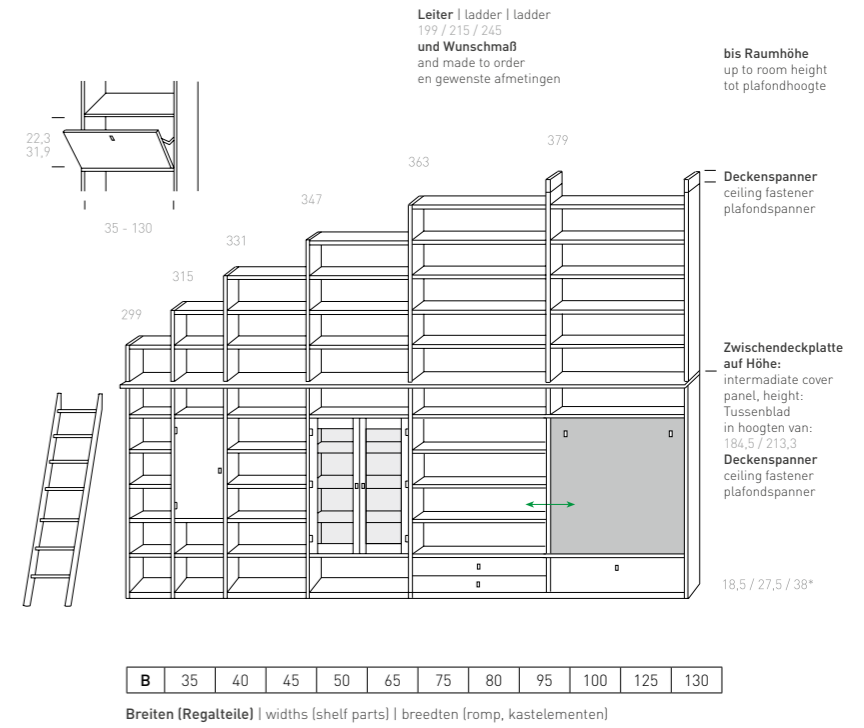

**cubus Schiebetüren** | sliding doors | schuifdeuren



**Variante Sichtfenster** | version window | variant zichtvenster

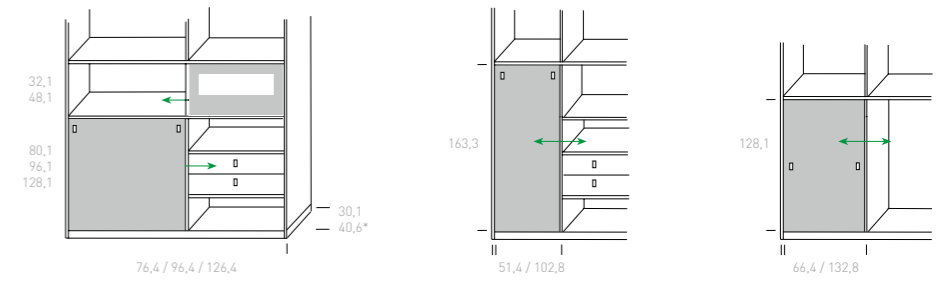

**Holzarten** | types of wood | houtsoorten

<b>ER</b> Erle alder elzenhout	<b>BK</b> Kernbuche beech heartwood kernbeuk	<b>KB</b> Kirschbaum cherry kersenhout	<b>AH-W</b> Ahorn Weißöl maple white oil esdoornhout witte olie	<b>Klappgriff Holz und Edelstahlknopf nur für Holzfront</b>   flap handle and knob stainless steel only for wood front klepgreep en rvs-knop alleen voor houten front
<b>BU</b> Buche beech beukenhout	<b>EI-N</b> Eiche Naturöl oak natural oil eikenhout olie naturel	<b>NB</b> Nussbaum walnut notenhout	<b>EI-W</b> Eiche Weißöl oak white oil eikenhout witte olie	<b>H</b> Höhe   height   hoogte <b>B</b> Breite   width   breedte <b>T</b> Tiefe   depth   diepte

**Farbglas glänzend oder matt**  
colored glass gloss or matte | gekleurd glas glanzend of mat

<b>WE</b> weiß (optiwhite) white wit	<b>KI</b> kiesel pebble kiezel	<b>SL</b> schlamm sludge mokka	<b>TP</b> taupe taupe taupe	<b>SW</b> schwarz black zwart
<b>SA</b> sand (optiwhite) sand zand	<b>BR</b> braun brown bruin	<b>BD</b> dunkelbraun dark brown donkerbruin	<b>AN</b> anthrazit anthracite antraciet	<b>PA</b> palladium palladium palladium

**Fronten Übersicht** | summary of fronts | Fronten - overzicht

<b>Holz</b> wood hout	<b>Glas auf Rahmen</b> glass glued on frame glas op raamwerk geplakt	<b>Rahmen mit Füllung Glas</b> Frame with center panel glass Raamwerk met binnenpaneel glas	<b>Holzrahmen mit Füllung Holz</b> woodframe with center panel wood houtraamwerk met binnenpaneel hout
-----------------------------	--	---	--

**Griffübersicht** | handle arrangement | grepenoverzicht

<b>Klappgriff Holz</b> flap handle wood uitklapbare handgreep hout	<b>Klappgriff Edelstahl</b> flap handle stainless steel uitklapbare roestvrij staal	<b>Klappgriff für Glas</b> flap handle for glass uitklapbare handgreep voor glas	<b>Edelstahlknopf</b> stainless steel knob roestvrijstalen knop	<b>Touchbeschlag Glas</b> touch fitting glass aanraakbeslag glas	<b>Touchbeschlag Holz</b> touch fitting wood aanraakbeslag hout
--	---	--	---	--	---