



Installation Instructions

Wall Mount Lavatory and Trap Cover

Thank you for selecting VitrA. VitrA makes everything you could dream of for the bathroom and they all share one thing-the highest quality.



PLEASE READ THE INSTRUCTIONS CAREFULLY BEFORE YOU BEGIN

The lavatory is shipped in one box.
The trap cover is shipped one box.

TOOLS AND MATERIALS REQUIRED FOR INSTALLATION

- Adjustable or socket wrench
- Putty knife
- Plumbers putty or caulking
- Pipe wrench
- Drill
- Tubing cutter
- Level
- Phillips screwdriver
- Regular screwdriver
- Basin wrench
- Saber saw
- Hacksaw
- Tape measure
- Pump plyers

Caution:

Risk of chipping or breaking. Remember to place the unit on carpet or cardboard during installation. Avoid dropping tools onto the ceramic units to eliminate any damage.

Save this instruction sheet for future reference concerning this product's operation and maintenance.

NOTE:

If replacing an existing lavatory, shut off the water supply before removing the old lavatory.

INSTALLING WALL MOUNT LAVATORY

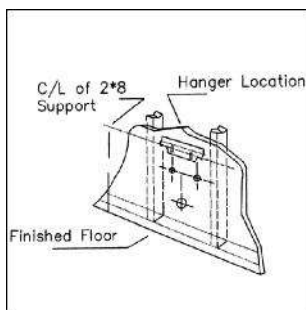

1 Provide suitable reinforcement behind the finished wall for the lavatory anchor screws. Determine the horizontal center line of the fixture.

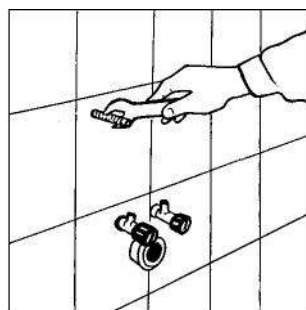

2 Mark the wall where the lavatory fixing bolts are to be installed and fix these bolts to the wall.

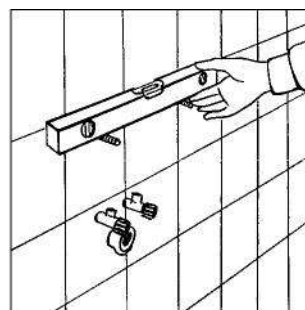

3 Before placing the lavatory onto these brackets ensure that these bolts are level.

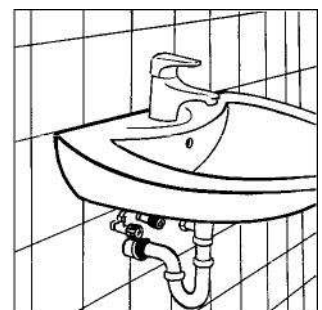

4 Fix the lavatory onto the wall.

INSTALLING TRAP COVER WITH WALL MOUNT LAVATORY

A- With Vitra-fix mounting (Total 12 steps)

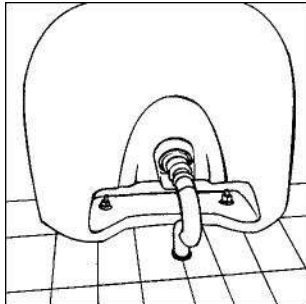

1 Install the lavatory.

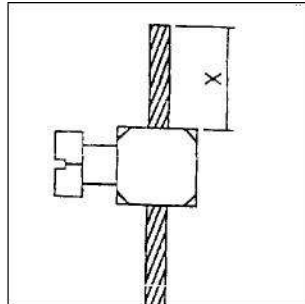

2 Reference the table on the following page. Find the suite name and product number to determine the length of X.

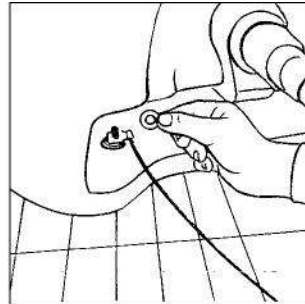

3 Settle the metal plate to prevent the sliding of the appliance during the fixing process. Insert the nut and fix it with a wrench.

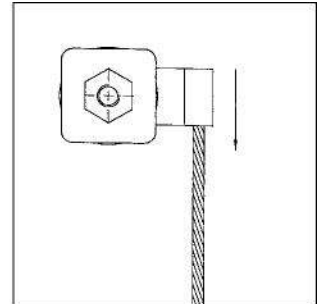

4 When the fixing process is over, the direction of the nut should be downwards, not left or right.

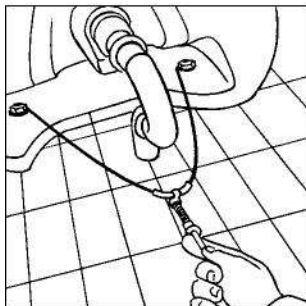

5 Center the screw.

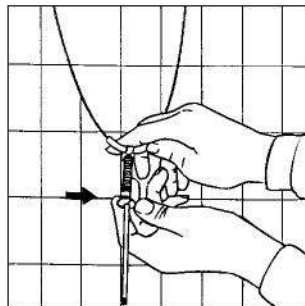

6 Remove the clamping nut.

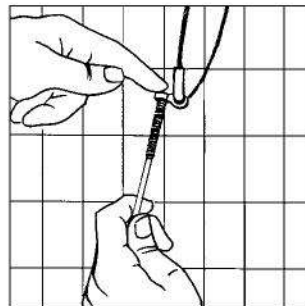

7 The tip of the screw should be even with the tip of the cap.

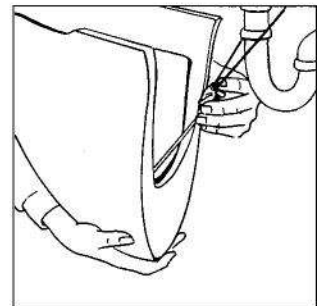

8 Pass the screw tap through the hole beneath the trap cover.



9 Install the trap cover against the lavatory and draw the screw tap downwards.

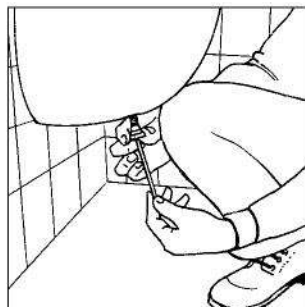

10 Install the clamping nut to the screw and fix it manually.

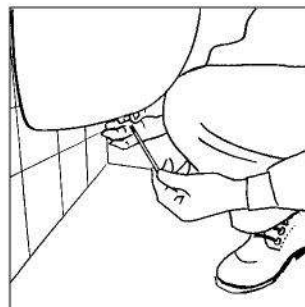

11 By holding the nut, the screw tap is demounted from its cap in the screw. (Keep the screw tap, you may need it again!)

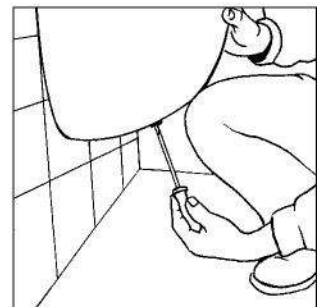

12 The fixing process is carried out and the trap cover is placed.



SUITE NAME	LAVATORY	COMPATIBLE TRAP COVER	FIXING TYPE		X
VICENTA	6156	6923	VitrA-fix	=	11"
	6157	6921	VitrA-fix	=	6 3/4"
	6158	6921	VitrA-fix	=	3 1/8"
	6159	6921	VitrA-fix	=	4"
	6116	6921	VitrA-fix	=	3 1/2"
	6117	6921	VitrA-fix	=	3 1/2"
	6149	6921	VitrA-fix	=	3 1/2"
IHLARA	6028	6447	VitrA-fix	=	0
	6025	6445	VitrA-fix	=	0
	6017	6445	VitrA-fix	=	0
NUOVA	5020	5027	VitrA-fix	=	6 3/4"
	5022	5028	VitrA-fix	=	5"
	5023	5028	VitrA-fix	=	5 1/4"
	5024	5028	VitrA-fix	=	5 1/4"
MONA	4005	4010	VitrA-fix	=	5 7/8"
	4006	4010	VitrA-fix	=	5 7/8"
	4007	4010	VitrA-fix	=	5 7/8"
NUOVELLA	4139	4148	VitrA-fix	=	5 1/2"
	4077	4148	VitrA-fix	=	4 3/4"
	4078	4148	VitrA-fix	=	3 1/8"
	4079	4148	VitrA-fix	=	3 1/8"
RIVA	6195	6918	Spring fixing		
	6198	6919	Spring fixing		
	6612	6919	Spring fixing		
ARKITEKT	5078	6948	Spring fixing		
	5079	6948	Spring fixing		
	5087	6948	Spring fixing		
	5088	6948	Spring fixing		
	5089	6948	Spring fixing		



INSTALLING TRAP COVER WITH WALL MOUNT LAVATORY

B- With spring mounting (Total 6 steps)

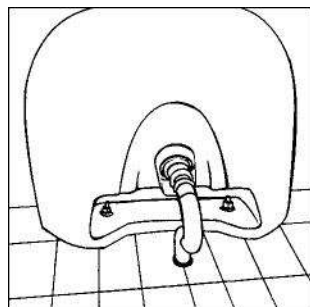

1 Install the lavatory.

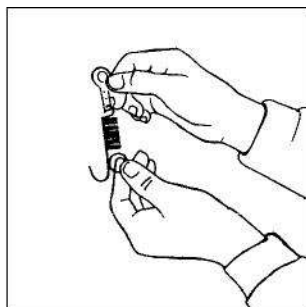

2 Attach the spring to the proper hole on the small metal lag.

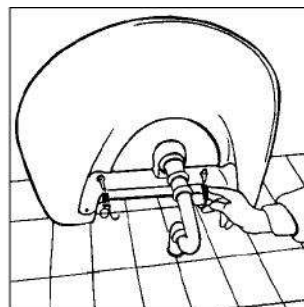

3 Place the lags through the big holes into the ends of the bolts.

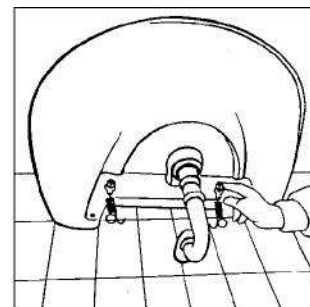

4 Fix in position with retaining nuts.

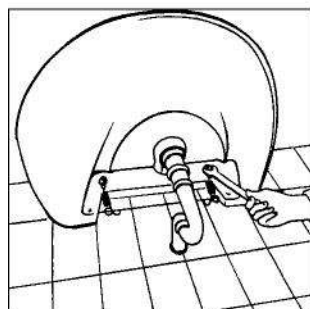

5 The nuts are tightened to keep the tag and the spring on the bolts.

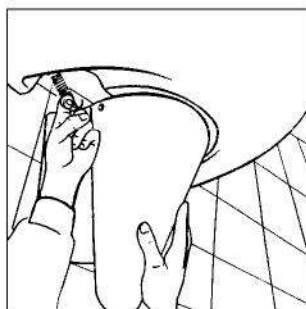

6 Position trap cover under the lavatory, pull down the spring and attach each spring into the hole on each side of the trap cover.

Caution:

Risk of chipping or breaking; do not over tighten the installing nuts.

PARTS SUPPLIED WITH THE UNIT:

For Wall Mount Lavatory:

A packet including; threaded bolts (2), caps and plastic lag anchors (2).

For Trap Cover to Section A:

A packet including; Vitra-fix set.

For Trap Cover Section B:

A packet including; Spring set

CARE and MAINTENANCE INSTRUCTIONS:

- Your new lavatory and trap cover can provide you with years of service.
- Cleaning should be done on a regular basis. The use of scouring powders is not recommended to prevent damage to the glaze. Wipe all outside surfaces with a soapy water solution and clean the bowl area with a non-abrasive type cleanser. The use of cleansers containing chlorine will cause damage and are not recommended.

REPAIR PARTS INFORMATION:

- Replacement parts should be obtained from Vitra - USA.
- Please contact our customer service for any information and to order. Before contacting our customer service, please note the model number of your lavatory and trap cover in order to obtain a timely solution. The model number is located under the product.
- Vitra - USA will not be responsible for any damage caused by changing repair parts which are not supplied by us or our representative.